

PHILIPS

Soundbar

5000 Series

TAB5706



User manual

Register your product and get support at
www.philips.com/support

1 Important

Read and understand all instructions before you use your product. If damage is caused by failure to follow instructions, the warranty does not apply.

Safety

Risk of electric shock or fire!

- Before you make or change any connections, make sure that all devices are disconnected from the power outlet.
- Never expose the product and accessories to rain or water. Never place liquid containers, such as vases, near the product. If liquids are spilt on or into the product, disconnect it from the power outlet immediately. Contact Consumer Care to have the product checked before use.
- Never place the product and accessories near naked flames or other heat sources, including direct sunlight.
- Never insert objects into the ventilation slots or other openings on the product.
- Where the mains plug or an appliance coupler is used as the disconnect device, the disconnect device shall remain readily operable.
- Battery (battery pack or batteries installed) shall not be exposed to excessive heat such as sunshine, fire or the like.
- Disconnect the product from the power outlet before lightning storms.
- When you disconnect the power cord, always pull the plug, never the cable.
- Use the product in tropical and/or moderate climates.

Risk of short circuit or fire!

- For identification and supply ratings, see the type plate at the back or bottom of the product.
- Before you connect the product to the power outlet, ensure that the power voltage matches the value printed on the back or bottom of the product. Never connect the product to the power outlet if the voltage is different.

Risk of injury or damage to this product!

- For wall mounting, this product must be securely attached to the wall in accordance with the installation instructions. Use only the supplied wall mount bracket (if available). Improper wall mounting may result in accident, injury or damage. If you have any query, contact Consumer Care in your country.
- Never place the product or any objects on power cords or on other electrical equipment.
- If the product is transported in temperatures below 5°C, unpack the product and wait until its temperature matches room temperature before connecting it to the power outlet.
- Parts of this product can be made of glass. Handle with care to avoid injury and damage.

Risk of overheating!

- Never install this product in a confined space. Always leave a space of at least four inches around the product for ventilation. Ensure curtains or other objects never cover the ventilation slots on the product.

Risk of contamination!

- Do not mix batteries (old and new or carbon and alkaine, etc.).
- CAUTION: Danger of explosion if batteries are incorrectly replaced.

Replace only with the same or equivalent type.

- Remove batteries if they are exhausted or if the remote control is not to be used for a long time.
- Batteries contain chemical substances, they should be disposed of properly.

Risk of swallowing batteries!

- The product/remote control may contain a coin/button type battery, which can be swallowed. Keep the battery out of reach of children at all times! If swallowed, the battery can cause serious injury or death. Severe internal burns can occur within two hours of ingestion.
- If you suspect that a battery has been swallowed or placed inside any part of the body, seek immediate medical attention.
- When you change the batteries, always keep all new and used batteries out of reach of children. Ensure that the battery compartment is completely secure after you replace the battery.
- If the battery compartment cannot be completely secured, discontinue use of the product. Keep out of reach of children and contact the manufacturer.



This is CLASS II apparatus with double insulation, and no protective earth provided.



AC voltage



Follow the instructions in the user manual!



WARNING!

Warning: risk of electric shock!



The exclamation mark is intended to alert the user to the presence of important operating instructions.

Care for your product

Use only microfiber cloth to clean the product.

Care of the environment

Disposal of your old product and battery



Your product is designed and manufactured with high quality materials and components, which can be recycled and reused.



This symbol on a product means that the product is covered by European Directive 2012/19/EU.



This symbol means that the product contains batteries covered by European Directive 2013/56/EU which cannot be disposed of with normal household waste. Inform yourself about the local separate collection system for electrical and electronic products and batteries. Follow local rules and never dispose of the product and batteries with normal household waste. Correct disposal of old products and batteries helps prevent negative consequences for the environment and human health.

Removing the disposable batteries

To remove the disposable batteries, see battery installation section.

Compliance

This product complies with the radio interference requirements of the European Community. Hereby, TP Vision Europe B.V. declares that this product is in compliance with the essential requirements and other relevant provisions of Directive 2014/53/EU. You can find the Declaration of Conformity on www.p4c.philips.com.

Help and support

For extensive online support, visit www.philips.com/support to:

- download the user manual and the quick start guide
- watch video tutorials (available only for selected models)
- find answers to frequently answered questions (FAQs)
- email us a question
- chat with our support representative.

Follow the instructions on the website to select your language, and then enter your product model number. Alternatively, you can contact Consumer Care in your country. Before you contact, note down the model number and serial number of your product. You can find this information on the back or bottom of your product.

2 Your Soundbar

Congratulations on your purchase, and welcome to Philips! To fully benefit from the support that Philips offers, register your Soundbar at www.philips.com/support.

What's in the Box

Check and identify the items in the package:

- Soundbar x 1
- Remote Control x 1
- AAA Batteries x 2
- Power Cord * x 3
- Wall Mount kit (Wall Brackets x2, Screws x2, Dowels x2) x 1
- Safety Sheet / Quick Start Guide Warranty Card x 1

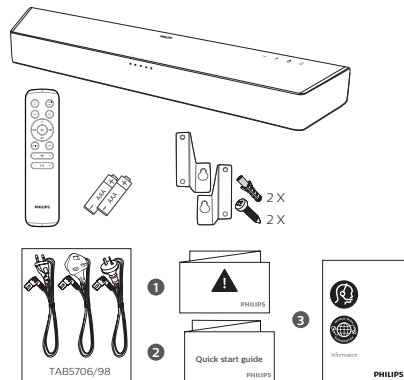



- * The attached items and images may vary by region.
- Images, illustrations and drawings shown on this User Manual are for reference only, actual product may vary in appearance.

Main unit

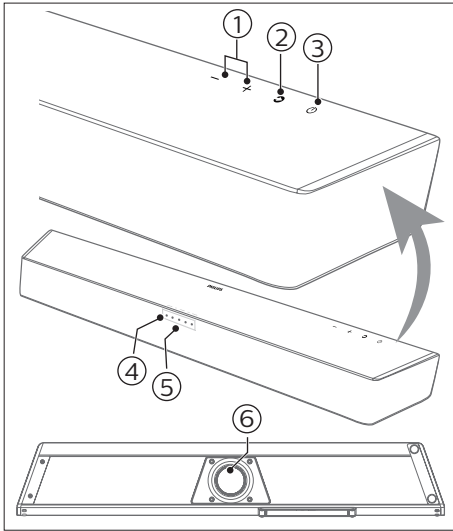
This section includes an overview of the main unit.



- 1 +/- (Volume)
Increase or decrease volume.
- 2  (Source)
Select an input source for the Soundbar.
- 3  (Standby-On)
Switch the Soundbar On or to Standby.
- 4 **Soundbar's LED indicator**
Switch the playback source and the front indicator lights up accordingly. The indicator light on the front of the main unit will show which mode is currently in use.

Status	LED State
AUX	[AUX/USB] Solid white
USB	[AUX/USB] Blinking white
Standby	[Standby] Solid red
BT (Bluetooth)	
· Connected	[BT] Solid white
· Connection	[BT] Blinking white
OPTICAL	[OPTICAL] Solid white
HDMI ARC	[HDMI ARC] Solid white

- 5 Remote Control Sensor
- 6 Built-in Subwoofer

Connectors

This section includes an overview of the connectors available on your Soundbar.

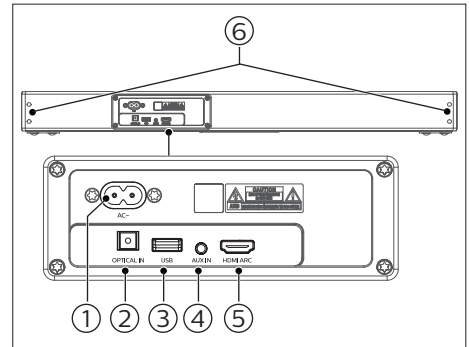

- 1 **AC~**
Connect to the power supply.
- 2 **OPTICAL IN**
Connect to an optical audio output on the TV or a digital device.
- 3  **USB**
 - Audio input from a USB storage device.
- 4 **AUX IN**
Audio input from, for example, an MP3 player (3.5mm jack).
- 5 **HDMI ARC**
The port supports the HDMI ARC feature. Connect to the HDMI ARC on the TV.
- 6 **Wall Bracket Screws**

Remote control

This section includes an overview of the remote control.

1 (Standby-On)

Switch the Soundbar on or to standby.

2 **Source buttons**

AUX: Switch your audio source to the AUX connection (3.5mm jack).

BT / Pair: Switch to Bluetooth mode.

Press and hold to activate the pairing function in Bluetooth mode or disconnect the existing paired Bluetooth device.

HDMI ARC: Switch your source to HDMI ARC connection.

OPTICAL: Switch your audio source to the optical connection.

USB: Switch to USB mode.

3 +/- (Soundbar's Volume)

Increase / decrease the soundbar's volume.

4 EQ

Select Equalizer (EQ) effect.

5 / (Previous/Next)

Skip to the previous or next track in USB/BT mode.

• (Play/Pause)

Start, pause or resume play in USB/ BT mode.

6 (Mute)

Mute or restore volume.

7 +/- (Subwoofer's Volume)

Increase / decrease the built-in Subwoofer's volume.

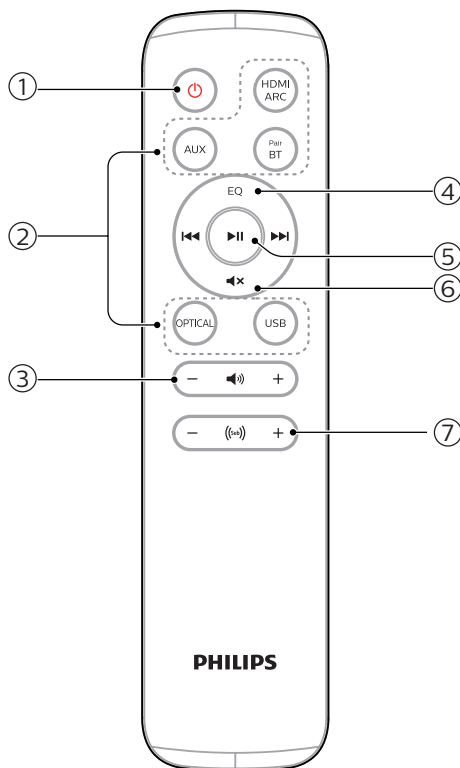

Prepare the Remote Control

- The provided Remote Control allows the unit to be operated from a distance.
- Even if the Remote Control is operated within the effective range 19.7 feet (6m), remote control operation may be impossible if there are any obstacles between the unit and the remote control.
- If the Remote Control is operated near other products which generate infrared rays, or if other remote control devices using infra-red rays are used near the unit, it may operate incorrectly. Conversely, the other products may operate incorrectly.

Replace the Remote Control Battery

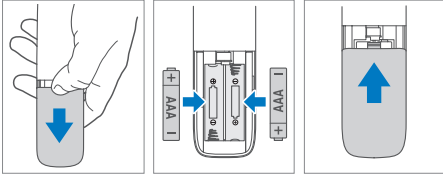

- 1 Press and slide the back cover to open the battery compartment of the remote control.
- 2 Insert two **AAA** size batteries (included). Make sure the (+) and (-) ends of the batteries match the (+) and (-) ends indicated in the battery compartment.
- 3 Close the battery compartment cover.

Precautions Concerning Batteries

- Be sure to insert the batteries with correct positive “⊕” and negative “⊖” polarities.
- Use batteries of the same type. Never use different types of batteries together.
- Either rechargeable or non-rechargeable batteries can be used. Refer to the precautions on their labels.
- Be aware of your fingernails when removing the battery cover and the battery.
- Do not drop the remote control.
- Do not allow anything to impact the remote control.
- Do not spill water or any liquid on the remote control.
- Do not place the remote control on a wet object.
- Do not place the remote control under direct sunlight or near sources of excessive heat.

- Remove the battery from the remote control when not in use for a long period of time, as corrosion or battery leakage may occur and result in physical injury, and/or property damage, and/or fire.
- Do not use any batteries other than those specified.
- Do not mix new batteries with old ones.
- Never recharge a battery unless it is confirmed to be a rechargeable type.

Placement

For best results, place your Soundbar as shown below.

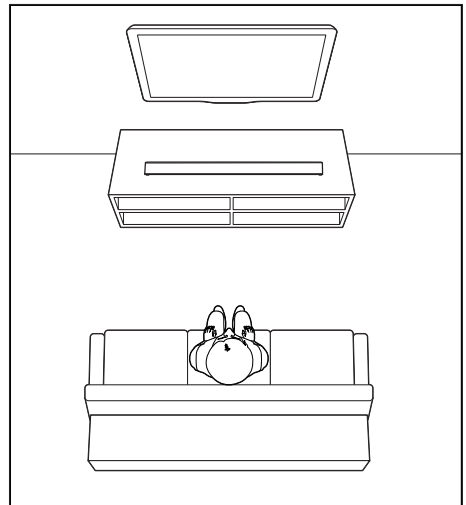

Wall mount

Note

- Improper wall mounting may result in accident, injury or damage. If you have any query, contact Consumer Care in your country.
- Before wall mounting, make sure the wall can support the weight of your Soundbar.
- Before wall mount, you need not remove the rubber feet at the bottom of the Soundbar, otherwise the rubber feet cannot be fixed back.
- Depending on the type of wall mounting your Soundbar, make sure that you use screws of a suitable length and diameter.
- Please check whether the USB port on the back of the Soundbar is connected to a USB device. If it is found that the connected USB device affects the wall-mount, you need to use another USB device of the appropriate size.

Screw length/diameter

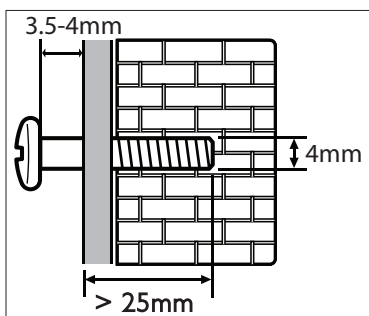

Suggested wall mounting height

You are recommended to install the TV first before wall mounting the soundbar. With a TV preinstalled, wall mount the soundbar 50mm/2.0" in distance from the bottom of the TV.

- 1 Drill 2 parallel holes (diameter 3-8mm each according to wall type) on the wall. The distance between the holes should be 646mm / 25.4".
↳ Secure the dowels and screws in the holes.
- 2 Remove the screws (x4) from the main unit.
↳ Attach the wall brackets (x2) to the main unit with the screws removed from the main unit.
- 3 Hang the Soundbar on the fastening screws.

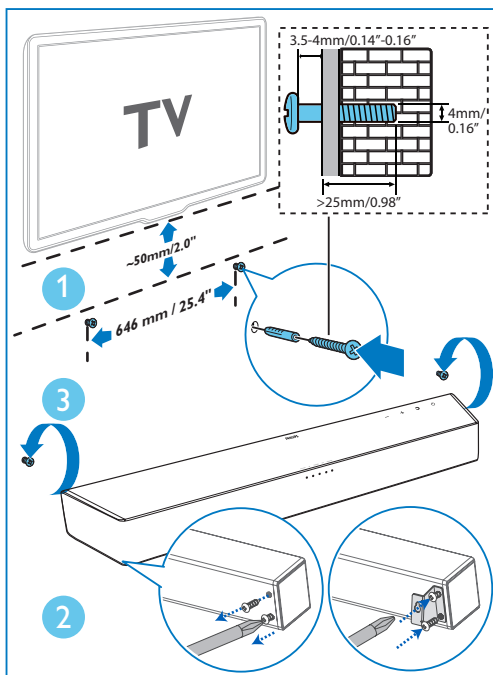

3 Connect

This section helps you connect your Soundbar to a TV and other devices, and then set it up.

For information about the basic connections of your Soundbar and accessories, see the quick start guide.

Note

- For identification and supply ratings, see the type plate at the back or bottom of the product.
- Before you make or change any connections, make sure that all devices are disconnected from the power outlet.

- The **HDMI ARC** connector on the TV might be labeled differently. For details, see the TV user manual.

- 2 Using a High Speed HDMI cable, connect the **HDMI ARC** connector on your Soundbar to the **HDMI ARC** connector on the TV.

Note

- Your TV must support the HDMI-CEC and ARC function. HDMI-CEC and ARC must be set to On.
- The setting method of HDMI-CEC and ARC may differ depending on the TV. For details about ARC function, please refer to your TV owner's manual.
- Make sure to use the HDMI cables can support the ARC function.

Connect to HDMI Socket

ARC (Audio Return Channel)

Your Soundbar supports HDMI with Audio Return Channel (ARC). If your TV is HDMI ARC compliant, you can hear the TV audio through your Soundbar by using a single HDMI cable.

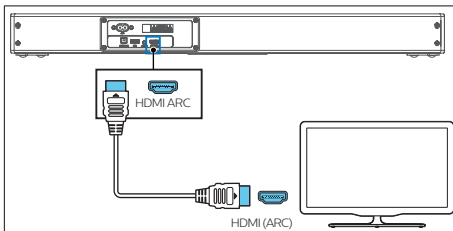

- 1 On your TV, turn on HDMI-CEC operations. For details, see the TV user manual.

Connect to Optical Socket

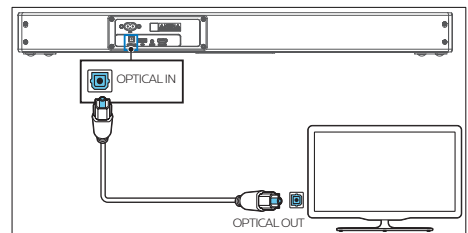

- 1 Using an optical cable, connect the **OPTICAL** connector on your Soundbar to the **OPTICAL OUT** connector on the TV or other device.
 - The digital optical connector might be labeled **SPDIF** or **SPDIF OUT**.

Connect to AUX Socket

- a. Use a 3.5mm to 3.5mm audio cable
- Use a 3.5mm to 3.5mm audio cable (not included) to connect the TV's headphone socket to the AUX socket on the unit.

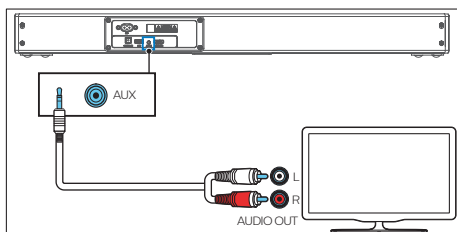
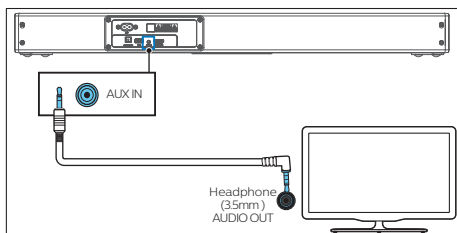

- b. Use a RCA to 3.5mm audio cable
- Use a RCA to 3.5mm audio cable (not included) to connect the TV's audio output sockets to the AUX socket on the unit.

Connect to Power

- Before connecting the AC power cord, ensure you have completed all other connections.
- Risk of product damage! Ensure that the power supply voltage corresponds to the voltage printed on the back or the underside of the unit.

- 1 Connect the mains cable to the AC~ Socket of the unit and then into a mains socket

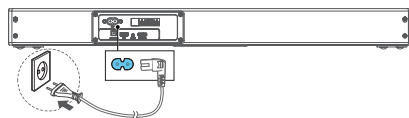

- * Power cord quantity and plug type vary by regions.

4 Use your Soundbar

This section helps you use the Soundbar to play audio from connected devices.

Before you start

- Make the necessary connections described in the quick start guide and the user manual.
- Switch the Soundbar to the correct source for other devices.

Turn ON and OFF

- When you first connect the unit to the main socket, the unit will be in STANDBY mode. The Standby indicator will light up.
- Press the  button on the remote control or on the main unit to switch the main unit ON or OFF.
- Disconnect the main plug from the main socket if you want to switch the unit off completely.

Auto Standby

The unit automatically turns to Standby mode after about 15 minutes if the TV or the external unit is disconnected, switched off.

- To switch the unit off completely, remove the mains plug from the mains socket.
- Please turn the unit off completely to save energy when not in use.

Select Source

- 1 Press the  button repeatedly on the unit or press the **AUX**, **OPTICAL**, **HDMI ARC**, **BT/Pair**, **USB** buttons on the remote control to select the desired mode.
 - ↳ The indicator light on the Soundbar will show which mode is currently in use.

Status	LED State
AUX	[AUX/USB] Solid white
USB	[AUX/USB] Blinking white
Standby	[Standby] Solid red
BT (Bluetooth)	
• Connected	[BT] Solid white
• Connection	[BT] Blinking white
OPTICAL	[OPTICAL] Solid white
HDMI ARC	[HDMI ARC] Solid white

Select Equalizer (EQ) Effect

Select predefined sound modes to suit your video or music.

- 1 Press the **EQ** button on the remote control to select your desired preset equalizer effects.
 - ↳ LEDs blink for 3 sec to show current EQ mode according to the EQ mode definition (Fig).
- **Movie** (5 LEDs blink): Create a surround listening experience. Ideal for watching movies.
 - **Music** (4 LEDs blink): Create two-channel or multichannel stereo sound. Ideal for listening to music.
 - **Voice** (3 LEDs blink): Create sound effect which makes human voice more clear and outstanding for listening.

- **Stadium** (2 LEDs blink): Create an atmosphere as if watching a sports game in a stadium.

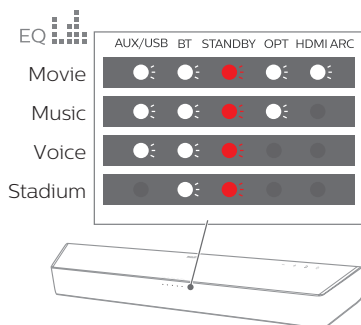

Adjust the Volume

When adjusting the volume of the soundbar and subwoofer, the status indicator will increase / decrease the amount of light. According to the corresponding light display / blinking, determine the current volume level of the soundbar and subwoofer.

Adjust the Soundbar's Volume

- 1 Press **⏮** +/- (**Volume**) to increase or decrease the soundbar's volume level.
 - To mute sound, press **⏮** x (**Mute**).
 - To restore the sound, press **⏮** x (**Mute**) again or press **Vol+**/**Vol-** (**Volume**).

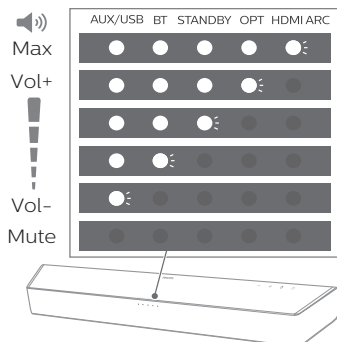

Adjust the built-in Subwoofer's Volume

- 1 Press **⏮** +/- (**sub**) to increase or decrease the built-in Subwoofer's volume.

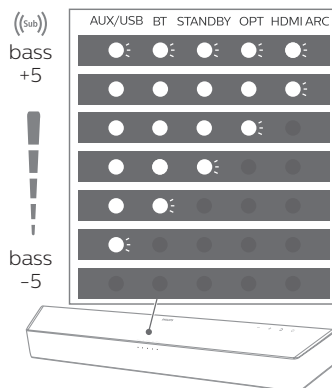

Factory Reset

Reset device to default setting

- 1 Press and hold vol- key for 8s in standby state, Soundbar will enter factory reset mode.
 - ↳ All LEDs light up for 5s, and then the Soundbar turn to standby state.
 - ↳ Volume is reset to 10, EQ mode to MOVIE, BT history list is cleaned, source to ARC.



Bluetooth Operation

Through Bluetooth, connect the Soundbar with your Bluetooth device (such as an iPad, iPhone, iPod touch, Android phone, or laptop), and then you can listen to the audio files stored on the device through your Soundbar speakers.

What you need

- A Bluetooth device which supports Bluetooth profile A2DP, AVRCP and with Bluetooth version as 4.2 + EDR.
- The maximum operational range between the Soundbar and a Bluetooth device is approximately 10 meters (30 feet).

- 1** Press the  button repeatedly on the unit or press **BT/Pair** button on the remote control to switch the Soundbar to Bluetooth mode.
↳ The BT indicator will blink.
- 2** On the Bluetooth device, switch on Bluetooth, search for and select **Philips TAB5706** to start connection (see the user manual of the Bluetooth device on how to enable Bluetooth).
↳ During connection, the BT indicator will blink.
- 3** Wait until you hear voice prompt from the Soundbar.
↳ If the successfully connected, the BT indicator will light up solidly.
- 4** Select and play audio files or music on your Bluetooth device.

- During play, if a call is coming, music play is paused. Play resumes when the call ends.
- If your Bluetooth device supports AVRCP profile, on the remote control you can press  /  to skip to a track, or press  to pause/resume play.

- 5** To exit Bluetooth, you can:
 - Switch the unit to another source.
 - Disable the function from your Bluetooth device. Or place your Bluetooth device out of the maximum operational range. The Bluetooth device will be disconnected from the unit after the voice prompt.
 - Press and hold the **BT/Pair** button on the remote control or the  button on the unit.

Tips

- The music streaming may be interrupted by obstacles between the device and Soundbar, such as wall, metallic casing that covers the device, or other devices nearby that operate in the same frequency.
- If you want to connect your Soundbar with another Bluetooth device, press and hold **BT/Pair** on the remote control to disconnect the currently connected Bluetooth device.

USB Operation

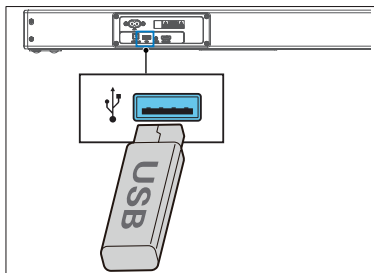

Enjoy audio on a USB storage device, such as an MP3 player and USB flash memory, etc.

- 1 Insert the USB device.



- 2 Press the  button repeatedly on the unit or press the **USB** button on the remote control to select **USB** mode.
 - ↳ [AUX/USB] LED indicator blinks white.

- 3 During playback:

Button	Action
	Start, pause or resume play
	Skip to the previous track
	Skip to the next track

Tips

- This product may not be compatible with certain types of USB storage devices.
- If you use a USB extension cable, USB hub, or USB Multifunctional card reader, the USB storage device may not be recognized.
- Do not remove the USB storage device while reading files.
- The unit can support USB devices with up to 32 GB of memory.
- This unit can play MP3 / WAV / WMA.
- Support a USB port: 5V \approx 500mA.

AUX / OPTICAL / HDMI ARC Operation

Ensure that the unit is connected to the TV or audio device.

- 1 Press the  button repeatedly on the unit or press the **AUX**, **OPTICAL**, **HDMI ARC** buttons on the remote to select the desired mode.
 - ↳ The indicator light on the Soundbar will show which mode is currently in use.

Status	LED State
AUX	[AUX/USB] Solid white
OPTICAL	[OPTICAL] Solid white
HDMI ARC	[HDMI ARC] Solid white

- 2 Operate your audio device directly for playback features.
- 3 Press the +/- (Volume) buttons to adjust the volume to your desired level.

Tip

- While in OPTICAL/HDMI ARC mode, if there's no sound output from the unit and the status Indicator flashes, you may need to activate **PCM** or **Dolby Digital** Signal output on your source device (e.g. TV, DVD or Blu-ray player).

5 Product specifications



Note

- Specifications and design are subject to change without notice.

Bluetooth

- Bluetooth Profiles: A2DP, AVRCP
- Bluetooth Version: 4.2 + EDR
- Frequency Band/Output Power: 2400 MHz ~ 2483.5 MHz / $\leq 5\text{dBm}$

Amplifier Section

- Power Output (rated): 100W RMS @10% THD

Main Unit

- Power Supply: 100-240V~ 50/60Hz
- Power Consumption: 30W
- Standby Consumption: $< 0.5\text{ W}$
- USB: 5V == 500mA
- Frequency Response: 40Hz - 20KHz
- Audio Input Sensitivity: 500mV
- Speakers Impedance: $8\Omega \times 2 + 4\Omega$
- Dimension (W x H x D) : 700 x 70 x 120 mm
- Weight: 2.5 kg
- Operating Temperature: $0^{\circ}\text{C} - 45^{\circ}\text{C}$

Remote Control

- Distance/Angle: 6m / 30°
- Battery Type: AAA (1.5V X 2)

Supported Audio formats

- **HDMI ARC**
Dolby Digital, Dolby Digital plus, LPCM 2ch
- **OPTICAL**
Dolby Digital, LPCM 2ch
- **BLUETOOTH**
SBC
- **USB**
MP3, WAV, WMA

6 Troubleshooting



Warning

- Risk of electric shock. Never remove the casing of the product.

To keep the warranty valid, never try to repair the product yourself. If you have problems using this product, check the following points before you request service. If you still have a problem, get support at www.philips.com/support.

Main unit

The buttons on the main unit do not work.

- Disconnect from the power supply for a few minutes, then connect again.

No power

- Ensure that the AC cord is properly connected.
- Ensure that there is power at the AC outlet.
- Press standby button on the remote control or Soundbar to turn the Soundbar on.

Sound

No sound from the soundbar speaker.

- Connect the audio cable from your soundbar to your TV or other devices. However, you do not need a separate audio connection when:
 - the soundbar and TV are connected through HDMI ARC connection, or
 - a device is connected to the HDMI IN connector on your soundbar.
- On the remote control, select the correct audio input.
- Make sure that the soundbar is not muted.

Bluetooth

A device cannot connect with the soundbar.

- The device does not support the compatible profiles required for the soundbar.
- You have not enabled the Bluetooth function of the device. See the user manual of the device on how to enable the function.
- The device is not correctly connected. Connect the device correctly.
- The soundbar is already connected with another Bluetooth device. Disconnect the connected device, then try again.

Quality of audio play from a connected Bluetooth device is poor.

- The Bluetooth reception is poor. Move the device closer to the soundbar, or remove any obstacle between the device and the soundbar.

I can't find the Bluetooth name of this unit on my Bluetooth device

- Ensure the Bluetooth function is activated on your Bluetooth device.
- Re-pair the unit with your Bluetooth device.

Remote control does not work

- Before you press any playback control button, first select the correct source.
- Reduce the distance between the remote control and the unit.
- Insert the battery with its polarities (+/-) aligned as indicated.
- Replace the battery.
- Aim the remote control directly at the sensor on the front of the unit.

This is a 15 mins power off function, one of the ERPII standard requirement for saving power

- When the unit's external input signal level is too low, the unit will be turned off automatically in 15 minutes. Please increase the volume level of your external device.

Trademarks:



The terms HDMI, HDMI High-Definition Multimedia Interface, and the HDMI Logo are trademarks or registered trademarks of HDMI Licensing Administrator, Inc.

Dolby Audio

Manufactured under license from Dolby Laboratories. Dolby, Dolby Audio, and the double-D symbol are trademarks of Dolby Laboratories Licensing Corporation.

Bluetooth®

The Bluetooth® word mark and logos are registered trademarks owned by Bluetooth SIG, Inc. and any use of such marks by MMD Hong Kong Holding Limited is under license. Other trademarks and trade names are those of their respective owners.



Specifications are subject to change without notice.

Please visit www.philips.com/support for the latest updates and documents.

Philips and the Philips Shield Emblem are registered trademarks of Koninklijke Philips N.V. and are used under license. This product has been manufactured by and is sold under the responsibility of MMD Hong Kong Holding Limited, or one of its affiliates, and MMD Hong Kong Holding Limited, is the warrantor in relation to this product.

