



SUBMARINE

WATERPROOF BLUETOOTH SPEAKER SYSTEM



X-2808
QUICK START

CAUTION: READ THIS BEFORE OPERATING YOUR UNIT.

TO ASSURE THE FINEST PERFORMANCE, PLEASE READ THIS MANUAL CAREFULLY. KEEP IT IN A SAFE PLACE FOR FUTURE REFERENCE.



The lightning flash and arrowhead within the triangle is a warning sign alerting you of "dangerous voltage" inside the product.

CAUTION

RISK OF ELECTRIC SHOCK
DO NOT OPEN

WARNING:

To reduce the risk of electric shock, do not remove cover (or back). No user-serviceable parts inside. Refer servicing to qualified service personnel.



CAUTION:

The exclamation point within the triangle is a warning sign alerting you of important instructions accompanying the product.

PLEASE NOTE: YOU WILL FIND THE RATING LABEL FOR THIS PRODUCT LOCATED ON THE REAR OF THE UNIT.

CAUTION: GROUNDING OR POLARIZATION: THE PRECAUTIONS SHOULD BE TAKEN SO THAT THE WIDER BLADE OF THE AC PLUG (OF AC-ADAPTOR) MUST MATCH THE SLOT IN RECEPTACLE "WALL SOCKET". (ONLY IF YOUR AC PLUG IS POLARIZED)

NOTE: CAUTION SYMBOLS ARE PRINTED ON REAR OF UNIT OR ACCESSORIES. PLEASE REFER TO INSTRUCTION MANUAL.

- KEEP MINIMUM DISTANCES (5cm) AROUND THE APPARATUS FOR SUFFICIENT VENTILATION.
- THE VENTILATION SHOULD NOT BE IMPEDED BY COVERING THE VENTILATION OPENINGS WITH ITEMS SUCH AS NEWSPAPER, TABLE-CLOTHS, CURTAINS ETC.
- NO NAKED FLAME SOURCE SUCH AS LIGHTED CANDLES SHOULD BE PLACED ON THE APPARATUS.
- ATTENTION SHOULD BE DRAWN TO THE ENVIRONMENTAL ASPECTS OF BATTERY DISPOSAL.
- BATTERY SHALL NOT BE EXPOSED TO EXCESSIVE HEAT SUCH AS SUNSHINE, FIRE OR THE LIKE.



DUST AND WATER
PROOF RATING

CARE REGARDING THE WATERPROOFING

ALTHOUGH THIS UNIT'S WATERPROOF DESIGN ALLOWS IT TO BE USED EVEN WHERE IT MAY BE EXPOSED TO A CERTAIN AMOUNT OF RAIN, SNOW, OR WATER SPRAY, YOU SHOULD NOTE AND OBSERVE THE FOLLOWING POINTS.

- Do not allow large amounts of water to contact this unit for long periods of time.
- Do not immerse or place this unit in water for more than a few minutes.
- If water droplets adhere to this unit, use a dry cloth to wipe them off as soon as possible. If this unit is exposed to a large amount of water, do not turn on the power immediately. Instead, let this unit dry out for at least one day in a dry location before you turn on the power.
- When using this unit in a wet or high-humidity location, please make sure all the Rubber Terminal Covers (Front and Back) are properly closed.
- The AC charger is not splash-proof; do not let it get wet.



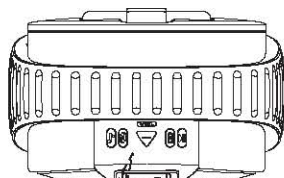

Display

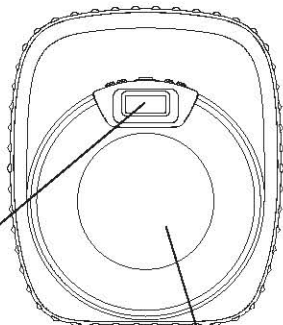

Waterproof Speaker

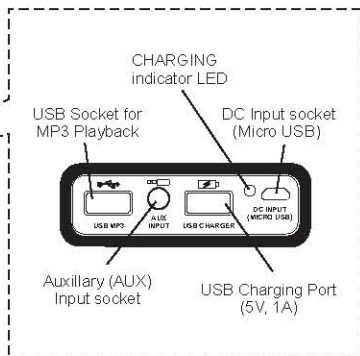
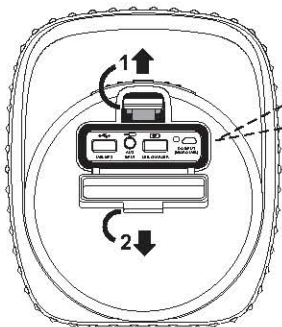
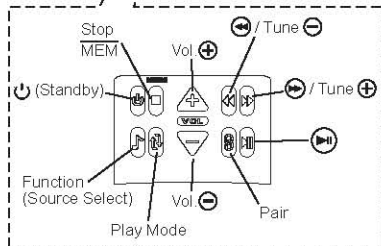

EN-2

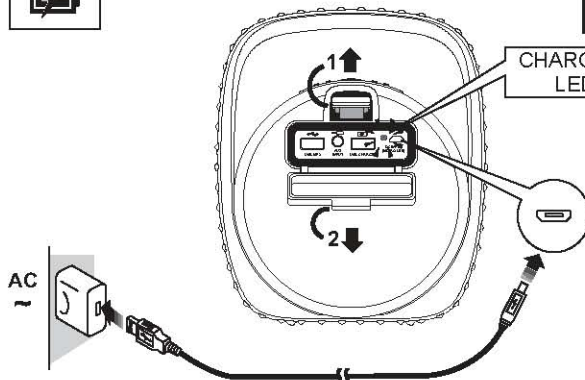

USB CHARGING PORT

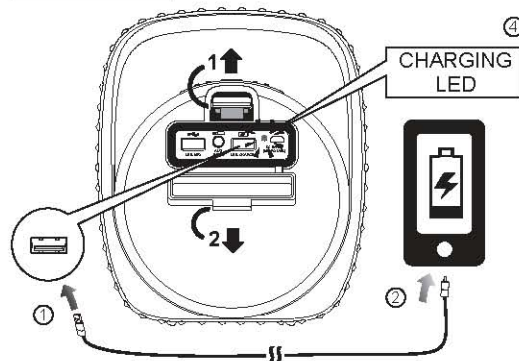

DC 5V 1A OUTPUT



PRESS & HOLD for 3 SEC.

EN-3

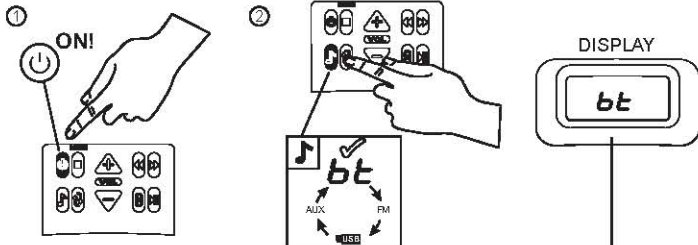

BT "ON" !

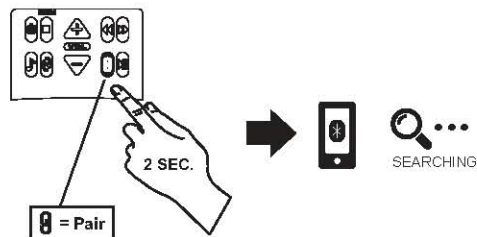
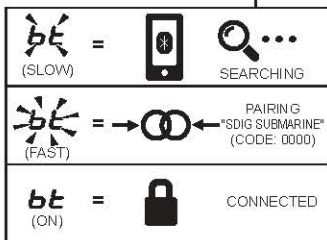

In order to avoid interferences, please de-activate Wi-Fi on your device (smartphone, tablet, etc.) when playing music using *Bluetooth*®

EN-4

USB-MP3

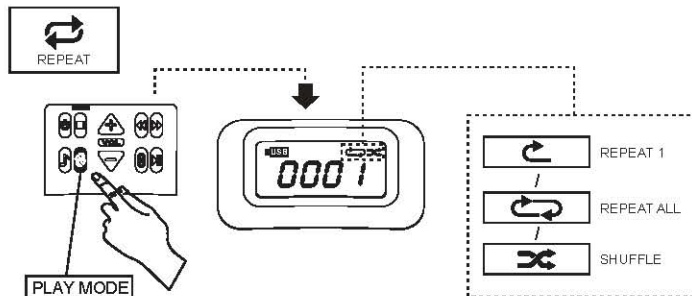
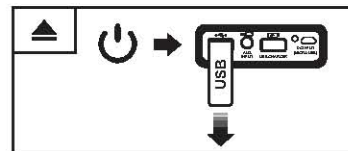
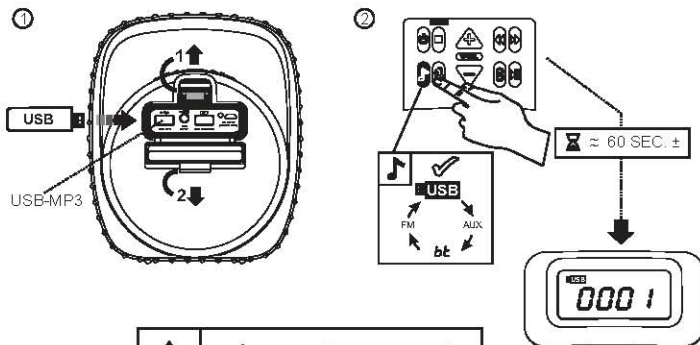

EN-5

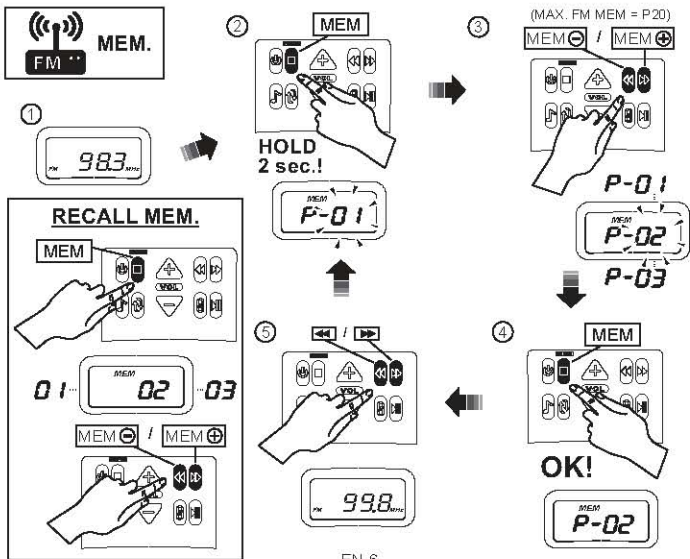
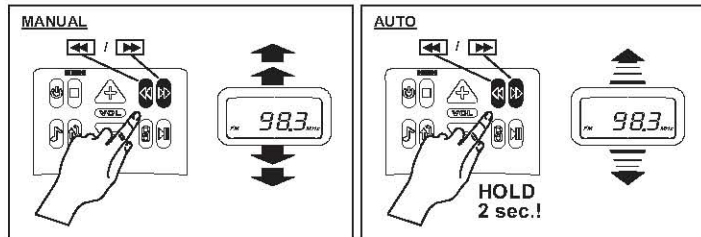
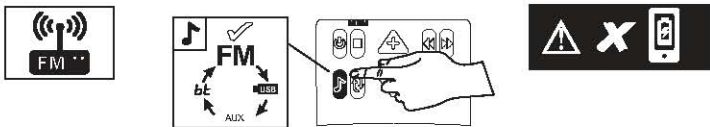

EN-6

AUX-INPUT

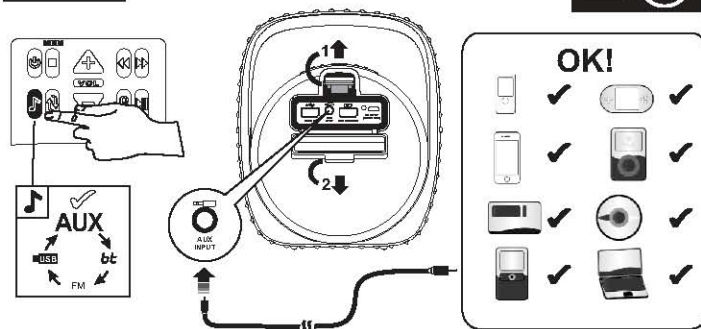

Product No.: X-2808-BTFM3U~4AH
 Product description: Waterproof Bluetooth Speaker System
 Power Supply : Rechargeable Lithium 3.7V/ 4000mAh X 1 PC. (Built-in)
 AC-Charger Output : DC 5V --- 1A
 Recharge Power : USB 5V --- 1A
 Radio Frequency : FM 87.5 - 108 MHz
 Speakers : 3.5"x1
 Wireless Range (BT) : 10M (30 Ft.)
 Max. BT Pairing Memory : 6 Devices
 FM Station Memory : 20 Stations

Technical specifications and design may change without notice.

EN-7